



sylvac

Swiss manufacturer of precision measuring instruments since 1969

SWISS
MADE

BESTSELLERS

2015

 **Bluetooth**
SMART

SYLVAC INTEGRATED BLUETOOTH® SERIES
INSTRUMENTS WITH BUILT-IN BLUETOOTH® TRANSCEIVER.
READY TO CONNECT, NO HIDDEN COST FOR MODULE!



IT'S TIME TO GET CONNECTED !

The Company

Sylvac SA

In Switzerland and throughout the world

The cradle of watch making and micro-technology, over the years the Swiss industry has forged a global reputation. The products manufactured in our country are evidence of quality recognised and appreciated throughout the whole world thanks to unique know-how.

A family business founded in 1969, Sylvac has almost 150 employees and manufactures all of its instruments in its workshops in French-speaking Switzerland. The unit in Wujiang, in China, supplies certain components and assembles calipers. For several decades, Sylvac has been a major and central player in the field of quality control.



100% swiss made



Bluetooth-Smart
Product Group



100% Data Connectivity



1 Nano Resolution

Sylvac



Lifetime Warranty
For All Dial Gauges



sylvac



Distributed by **LFC**

FROM

S\$229

THE BEST SELLER

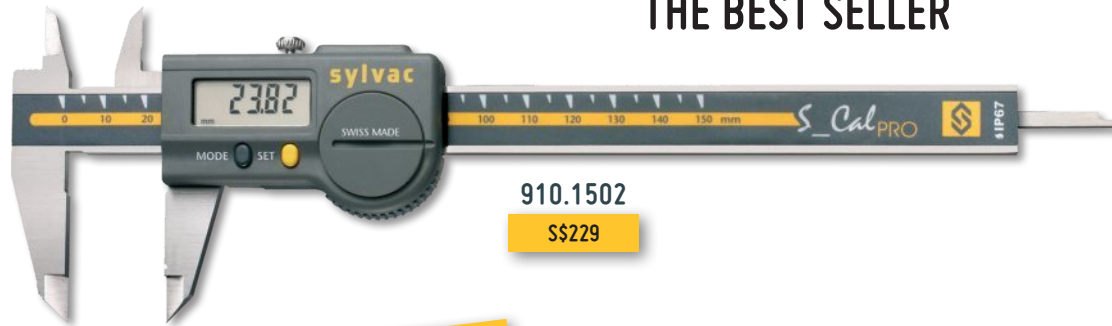

910.1502

S\$229

Special Offer

Buy 4x calipers and get a FREE S_Cal PRO 150 or 2x data cable

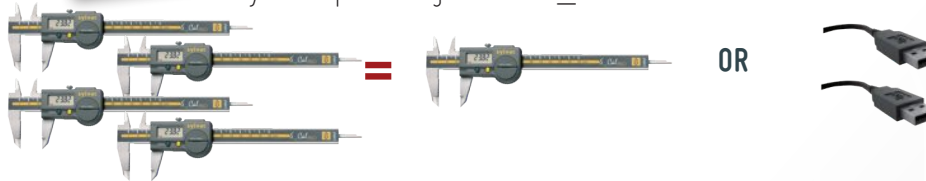

S_Cal PRO

Professional calipers coolants and lubricants protected IP67. Sleeping mode after 20 minutes with automatic wake-up by moving the electronic. Position memorized in sleeping mode (Absolute system*).

Order number	Range (mm)	Resolution (mm)	Depth rod (mm)	Max Error (µm)
910.1502	150	0.01	4x1.4	20
910.1507	150	0.01	∅ 1.5	20
910.1522	200	0.01	4x1.4	30
910.1532	300	0.01	-	30

S_Cal PRO µm

WITH MICRON RESOLUTION !



EXCELLENT 4 µm REPEATABILITY.

Order number	Range (mm)	Resolution (mm)	Depth rod (mm)	Max Error (µm)
910.9502	150	0.001	4x1.4	15
910.9707	150	0.001	∅ 1.5	15



910.9502

S\$399

**IP67
DIN 862**



Sylvac BT Smart App

Special Offer

FREE GIFTS WORTH \$360!

Pack A
Buy 3x Bluetooth® calipers and get a free dongle!

Pack B
Buy 5x Bluetooth® calipers and get a free dongle and a free Vmux!





**FROM
\$299**

S_Cal EVO Bluetooth®

Professional Bluetooth® calipers coolants and lubricants protected IP67. Sleeping mode after 20 minutes with automatic wake-up by moving the electronic. Large display, customizable ergonomic button.

Order number	Range (mm)	Resolution (mm)	Depth rod (mm)
810.1506	150	0.01	4x1.4
810.1516	150	0.01	∅ 1.5
810.1526	200	0.01	4x1.4
810.1536	300	0.01	-
981.7100	USB Dongle Bluetooth® for PC Windows / D300S		
981.7161	Software Vmux		

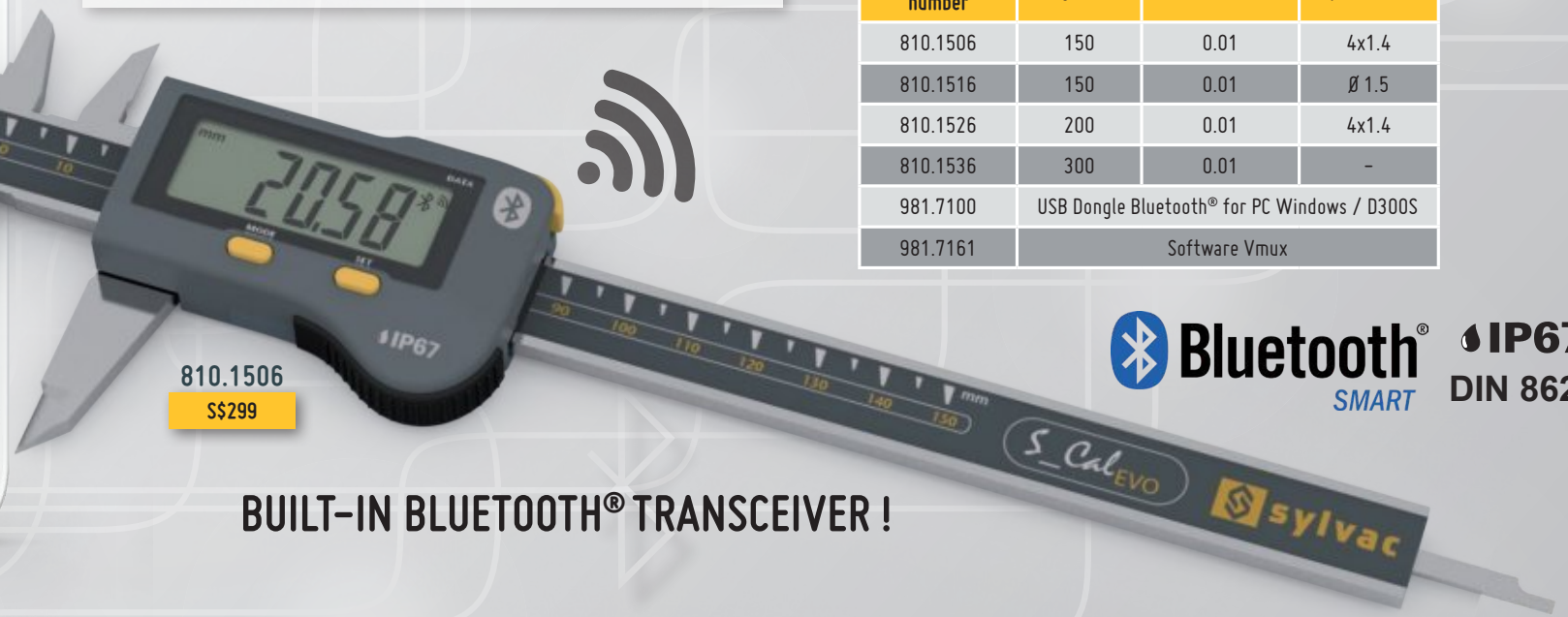

**810.1506
\$299**

Bluetooth® SMART **IP67
DIN 862**

BUILT-IN BLUETOOTH® TRANSCEIVER !



sylvac

Distributed by **LFC**



FROM

S\$1799

NEW



3m = 3.3 kg

ULTRA-LIGHT LONG CALIPERS

UL4

Ultimate calipers for big external and internal dimensions up to 3000 mm. Reinforced aluminium frame, big display with built-in Bluetooth® transceiver, force control system, long jaws coated with titanium.

Order number	Range (mm)	Repeatability (µm)	Max error (µm)	Weight (kg)
811.1404	0-400	20	30	1.5
811.1406	0-600		40	1.6
811.1410	0-1000		50	1.9
811.1415	0-1500	30	90	2.3
811.1420	0-2000		120	2.6
811.1425	0-2500		150	2.9
811.1430	0-3000		200	3.3



811.1404
S\$1799

IP67
DIN 862



Internal measurement

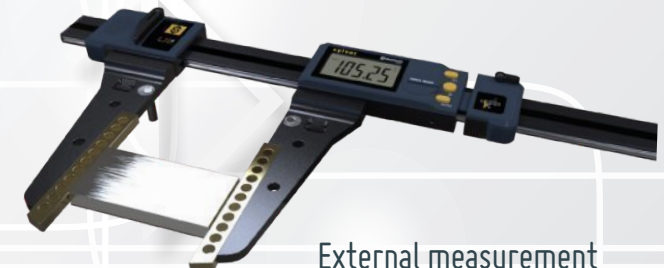

External measurement

200MM



UNICAL

Version without jaws of our UL4 caliper on which you can mount a wide range of accessories, for many external and internal applications.

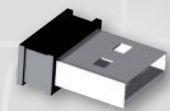

981.7161
\$269

981.7100
\$99

Order number	Description
981.7100	USB Dongle Bluetooth® for PC Windows / D300S
981.7161	Software Vmux



sylvac

Distributed by **LFC**



FROM

S\$499

S_Mike PRO

Professional micrometers coolants and lubricants protected IP67. Sleeping mode after 20 minutes with automatic wake-up by moving the spindle. Position memorized in sleeping mode (Absolute system*). Quick displacement of the measuring spindle 12 mm per rotation. High repeatability, the operator cannot influence the measurement result. Available in several versions with different anvils.



903.1600

903.1360

903.1000

903.0600

903.0300

S\$499



Set 910.1301

S\$950



Set 903.1301

S\$2050

ULTRA FAST SPINDLE SYSTEM!

**IP67
DIN 862**

Order number	Range (mm)	Anvils (mm)	Repeatability (µm)
903.0300	0-30	∅ 6.5	1
903.0600	30-66	∅ 6.5	1
903.1000	66-102	∅ 6.5	1
903.1360	100-136	∅ 6.5	2
903.1600	125-161	∅ 6.5	2
903.1301	0-102 (3x instr.)	∅ 6.5	1
910.1301	1x caliper + 1x mike + micrometer stand	-	-



S_Mike PRO Bluetooth®

Our popular quick micrometer is now available with built-in Bluetooth® transceiver.



NOW WITH BLUETOOTH® EMBEDDED

FROM

S\$599



903.0306
S\$599

**IP67
DIN 862**

Order number	Range (mm)	Anvils (mm)
903.0306	0-30	∅ 6.5
903.0606	30-66	∅ 6.5
903.1006	66-102	∅ 6.5
981.7100	USB Dongle Bluetooth® for PC Windows / D300S	
981.7161	Software Vmux	

S_Mike PRO Disk

Order number	Range (mm)	Anvils (mm)
903.0303	0-30	∅ 25

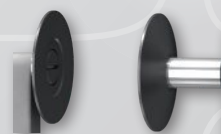

903.0303
S\$1499

S_Mike PRO Knife & ∅2mm

Order number	Range (mm)	Anvils (mm)
903.0301	0-25	∅ 2
903.0302	0-25	0.75x6.5

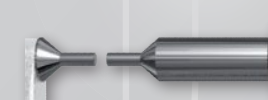

903.0301
S\$688



903.0302
S\$899

S_Mike PRO Flat-Ball & Ball-Ball

Order number	Range (mm)	Anvils (mm)
903.0304	0-30	∅ 7 flat & ∅ 7 spherical
903.0305	0-30	2x ∅ 7

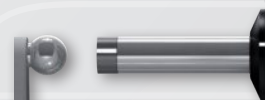

903.0304
S\$899



903.0305
S\$988



sylvac



Distributed by **LFC**

FROM

S\$1900



X_Treme XTH and XTD **IP65**

Our popular XTreme bore gauges series, available in handle or dial type. Large measuring range \varnothing 2–300 mm. All instruments are delivered with setting ring(s) and certificates. Coolants and lubricants protected IP65. Special heads for grooves, slots, threads, splines, etc. can be customized on request.

X_Treme 3

NEW

IP67

New version of our successful XTreme bore gauges series redesigned with larger LCD display and optional built-in Bluetooth® transceiver. Coolants and lubricants protected IP67.



SPECIAL HEADS



*available on request.





Lifetime Warranty  **SWISS MADE**

FROM

S\$499

Sylvac Stands for indicators

Swiss made high quality granite stands for indicators. Very rigid construction with fine adjustment of the position in height. Granite grade 00.

Order number	Dimensions (mm)	Clamping (mm)	A (mm)	B (mm)
808.1204	200x300x60	ø8	115	ø35
808.1206	100x150x40	ø8	70	ø25
808.1207	100x150x40	ø8	70	ø35
808.1203	140x240x40	ø8	70	ø35
808.1201	140x240x40	ø8	115	ø35

LONG RANGE INDICATORS WITH HIGH ACCURACY!

POWERED BY STANDARD BATTERY



805.8601
S\$1949

808.1207
S\$570

 WATER RESISTANT

ø 25MM

ø 8MM

FROM

S\$1499



1 NANO RESOLUTION

S_Dial PRO Basic

Long range indicators with 0.1 micron resolution. Incredible accuracy over 100 mm. Low measuring force, clamping diameter 8 mm and 25 mm.

Lifetime Warranty



Order number	Range (mm)	Measuring force (N)	Accuracy (µm)	Clamping (mm)	Repeatability (µm)
805.8501	25	0.75 - 1.00	1.3	ø8 h6	0.2
805.8502	25	0.30	1.3	ø8 h6	
805.8601	50	0.75 - 1.15	1.5	ø8 h6	
805.8602	50	0.75 - 1.15	1.5	ø25 g7	
805.8701	50	0.40	1.5	ø8 h6	
805.8702	50	0.40	1.5	ø25 g7	
805.8661	100	0.90 - 1.30	2.2	ø8 h6	

FROM

S\$749



S_Dial WORK BLUETOOTH® SERIES

High quality and very robust indicators with built-in Bluetooth® transceiver bringing new solutions for data collection. Duplex transmission mode allowing to send commands from the computer or device connected. Displayed values are synchronized after zero or presetting. Available in 3 different models.

Order number	Model	Range (mm)	Resolution (mm)	Max error (µm)	Repeatability (µm)
805.6301	Advanced BT	12.5	0.001	3	2
805.6501	Advanced BT	25	0.001	4	
805.6621	Advanced BT	50	0.001	5	
805.6661	Advanced BT	100	0.001	6	
805.6307	Ana. Nano BT	12.5	0.0001	1.8	0.5
805.6507	Ana. Nano BT	25	0.0001	2.2	
805.6306	Nano BT	12.5	0.0001	1.8	
805.6506	Nano BT	25	0.0001	2.2	

BEST ACCURACY AVAILABLE ON THE MARKET

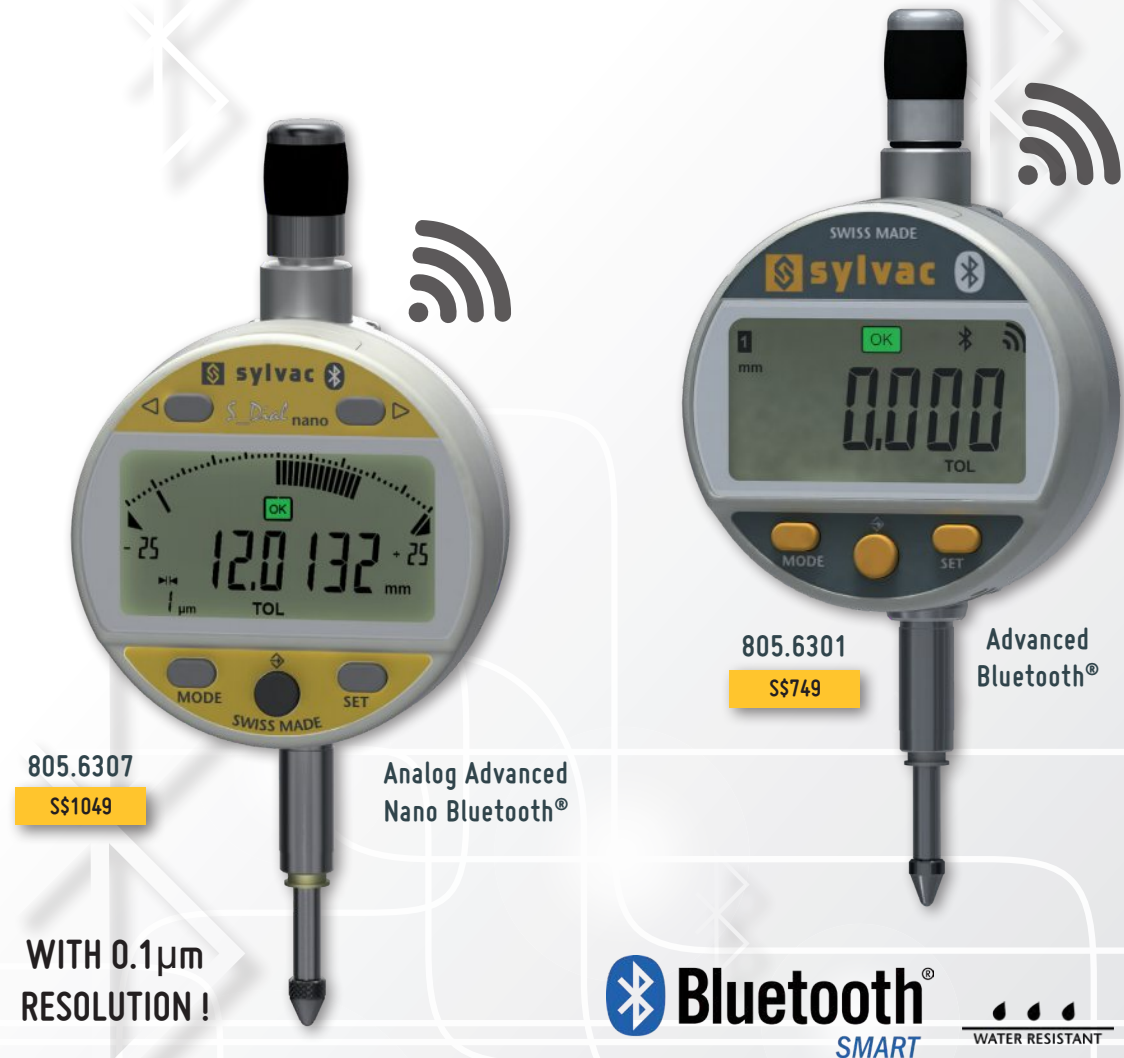

805.6307
S\$1049

Analog Advanced Nano Bluetooth®

WITH 0.1µm RESOLUTION !

805.6301
S\$749

Advanced Bluetooth®





805.6306
S\$999

Advanced Nano
Bluetooth®
**WITH 0.1µm
RESOLUTION !**



Sylvac BT Smart App

Order number	Description	Price (SGD)
981.7100	USB Dongle Bluetooth® for PC Windows / D300S	99
981.7161	Software Vmux	269
981.7110	Software Sylconnect	499

Special Offer

PROMOTION FREE SOFTWARE !

Pack A

Buy 2x Bluetooth® indicators and get a free dongle!

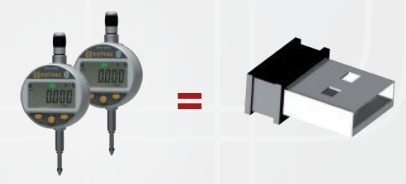

Pack B

Buy 4x Bluetooth® indicators and get a free dongle and a free Sylconnect or a free Vmux !

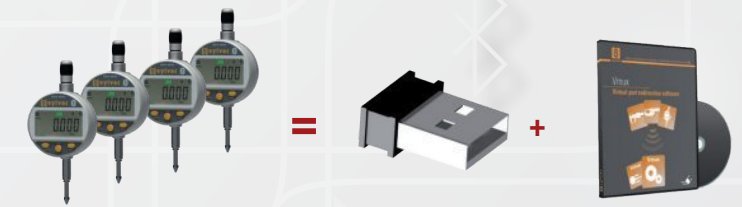

Pack C

Buy 8x Bluetooth® indicators and get 2 free dongles and 2 free Sylconnect or 2 Vmux !

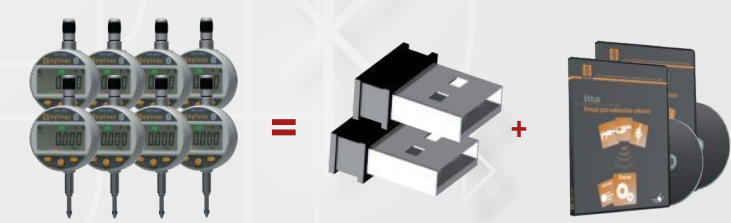

SAVE \$1196!



sylvac

Lifetime Warranty

Distributed by

FROM

S\$299

**EASY TO USE, ONE BUTTON
ONE FUNCTION**



805.1301

S\$349

S_Dial Work
Basic

Order number	Range (mm)	Resolution (mm)	Max error (µm)
805.1201	12.5	0.01	10
805.1301	12.5	0.001	4
805.1401	25	0.01	10
805.1501	25	0.001	5
805.1601	50	0.01	20
805.1621	50	0.001	7

S_Dial WORK Basic & Advanced

High quality and very robust digital indicators range coolants and lubricants protected. Sleeping mode after 20 minutes with automatic wake-up by moving the spindle. Position memorized in sleeping mode (Absolute system*). Function assigned to the button programmable by PC.



SIS Smart Inductive System

Functions	Basic	Advanced
Preset	• ¹⁾	•
Preset on Min/Max		•
Measuring direction		•
Hold		•
Min / Max / Delta		•
Tolerances		•
Absolute system*	•	•
Auto off	•	•
Multiplication factor		•
Ref I / II		•

Lifetime Warranty



S_Dial Work
Advanced

805.5301

S\$599

**BEST ACCURACY
ON THE MARKET**

Order number	Range (mm)	Resolution (mm)	Max error (µm)
805.5201	12.5	0.01	10
805.5301	12.5	0.001	3
805.5401	25	0.01	10
805.5501	25	0.001	4
805.5601	50	0.01	20
805.5621	50	0.001	5
805.5641	100	0.01	20
805.5661	100	0.001	6
805.5671	150	0.01	20
805.5681	150	0.001	10

¹⁾ Preset configuration only by PC.

*instruments equipped with a Smart Inductive Sensor with an extremely low power sleeping mode.



SOLUTIONS FOR SMALL MEASUREMENTS

FROM

S\$2888

Bench Table PS15, PS16V2, PS17

Made specially for measuring internal and external diameters of small components up to 70mm in size. Quick release pedal allows fast and precise measurements. Heavy duty construction for excellent accuracy and repeatability.

Large variety of options for clamping and contact anvils, and usable with probes or digital dial gauges.



PS15H



PS15

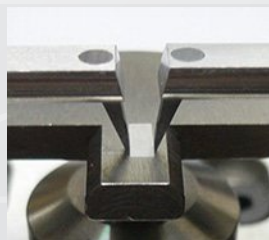
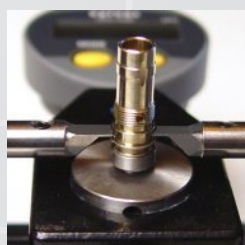
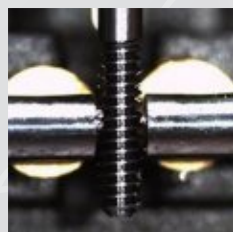
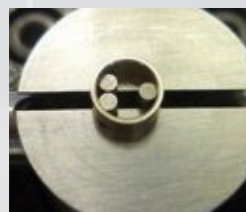

PS16V2

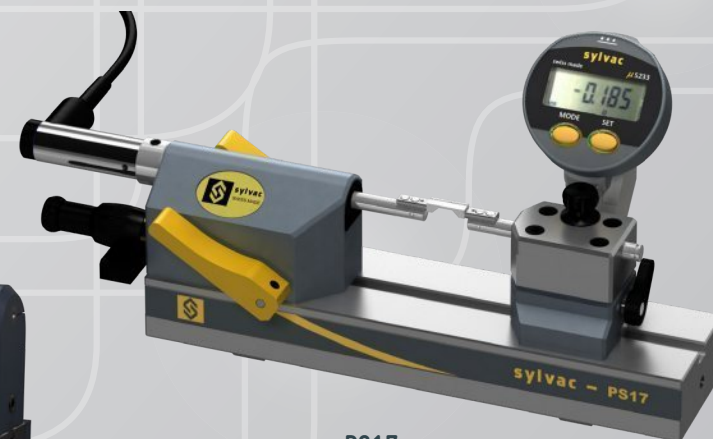

PS17



sylvac

Distributed by LFC



FROM

\$S1699

TOUCH SCREEN 2 CHANNELS DISPLAY UNIT

COMPATIBLE WITH MOST OF THE PROBES ON THE MARKET !



Digital display units **D70S/H/I**

Digital display units with 4.3" touch screen interface and 2 probes input, compatible with Excel and SPC.

Available in 3 different versions :

- D70S for Sylvac capacitive probes
- D70I for Sylvac and other brands inductive probes
- D70H for incremental or 1VPP probes.

Order number	Model	Probes
804.2071	D70I	Inductive Sylvac
804.2072	D70H	incremental or 1VPP
804.2072	D70S	Capacitive Sylvac

*accessories and probes not included

IP65
Front face



SOLUTIONS FOR MULTIGAUGING APPLICATIONS

FROM

\$2999



804.1310

\$2999

*accessories and probes not included

Digital display units D300S V2

Touch-screen multifunctional unit compatible with M-BUS system, USB Sylvac cables and Bluetooth instruments.

- up to 8 channels displayed simultaneously
- Max. 32 instruments connected
- Up to 16 instruments connected by Bluetooth®

Order number	Model	Probes/Instruments
804.1300	D300S V2	6 USB, M-BUS Bluetooth® compatible
804.1310	D300S V2	6 USB, 2 probe input Bluetooth® compatible
981.7100	USB Dongle Bluetooth® for PC Windows / D300S	



D400S

\$3500

Digital display units D400S

Touch-screen multifunctional unit compatible with M-BUS system.

- up to 32 channels displayed simultaneously
- Max. 99 instruments connected

Order number	Model	Probes/Instruments
804.2400	D400S	Connection through M-BUS modules





sylvac

Distributed by LFC

FROM

S\$749

M-bus & M-bus RS modules

M-Bus : Interface modules used to connect probes and instruments from different brands to Sylvac D300S and D400S units.

M-Bus RS : Master module designed to connect M-BUS module(s) to computer without passing by display unit.



Order number	Model	Probes / Instruments	Inputs
840.2102	MB-2C	Capacitive Sylvac	2
840.2104	MB-4C		4
840.2108	MB-8i	Inductive Sylvac	8
840.2122	MB-2S	Incremental	2
840.2114	MB-4D	Digimatic	4
840.2118	MB-8D		8
840.2130	MB-10	PLC I/O	8
840.2160	MB-RS	M-BUS -> Computer	255

900.1101
S\$450

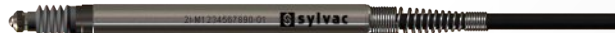

900.1102
S\$599



Sylvac Inductive probes series

FROM

S\$450

Robust and long lasting ball bearing guidance inductive probes specially designed for multi gauging applications. Excellent repeatability allowing to measure by comparison on jigs and fixtures. Available in 2 versions :

- Spring push (force given by spring)
- Pneumatic push (force given by air)

Order number	Model	Push	Travel	Max error (µm)	Repeatability (µm)	Force - Standard (N)
900.1101	P2i	Spring	±2	2	0.15	0.7
900.1102	P2iP	Pneumatic	±5	2	0.15	0.85/0.4 Bar - 2/0.8 Bar
900.1111	P5i	Spring	±2	5	0.15	0.7
900.1112	P5iP	Pneumatic	±5	5	0.15	0.85/0.4 Bar - 2/0.8 Bar

*for more probes, kindly request for full catalogue



Hi_Cal 150/300/450

Best seller 1D motorized height gauge specially designed to quickly measure heights, distances, internal and external diameters, centerline distances, etc.

Big display with intuitive functions. Very small base requiring only a small granite.

Order number	Range (mm)	Resolution (mm)	Accuracy (µm)
830.0150	150	0.001	2.5+L/175
830.0300	300	0.001	2.5+L/175
830.0450	450	0.001	2.5+L/175
930.2150	Accessory kit (full)		
930.2151	Accessory kit (basic)		

FREE GIFTS Worth \$1300!



930.2150

OR



Granite Table with stand

*with purchase of Hi_Cal 450



830.0450

\$8500



FROM

\$1199

Hi_Gage ONE 400/600

Top quality measuring and scribing instrument with heavy duty construction. Self and quick locking system of the unit with fine adjustment knob.

Supplied with 840.9002.

EASY TO USE

Order number	Resolution (mm)	Range (mm)	Accuracy (µm)
840.0400	0.01	400	40
840.0600	0.01	600	50
840.9001	Ball probe Ø 8mm		
840.9002	Scribing probe (standard included)		
905.2247	Clamping stem Ø 8mm		
905.4321	Test indicator short		



905.2247



840.9002



840.9001

905.4321

\$499



840.0400

\$1199



sylvac

+ SWISS
MADE

Sylvac Lifetime Warranty

First time ever! Confident in our Swiss quality standard, Sylvac offers a Lifetime Warranty on all S_Dial Work and S_Dial Pro Series digital indicators. To enjoy this incredible guarantee, simply register your instrument on our website within 30 days after the purchase date.



Lifetime Warranty

Lifetime
Warranty



To register your new indicator
Just visit:

www.sylvac.ch/LifetimeWarrantyRegistration

Respective GST/VAT Excluded

Products sold in Indonesia will be quoted in IDR at prevailing rates
Images may differ from reality. Change without prior notice



Sales Agent for Singapore and Indonesia

LFC PTE. LTD.
8 Ubi Road 2, #03-01, Zervex
Singapore 408538
Tel: +65 6749 9697
email: sales@lfc.com.sg
Web: www.lfc.com.sg

PT. LFC TEKNOLOGI INDONESIA
Gedung Graha Pena, Kota Batam
Indonesia 29461
Tel: +62 778 464 465
email: sales@lfc.co.id
Web: www.lfc.co.id

SYLVAC SA Ch. du Cloislet 16 CH-1023-Crissier

Tél: +41 (0) 21 637 67 57 Fax: +41 (0) 21 637 67 40
E-mail: vente@sylvac.ch Web: www.sylvac.ch